



**PHOENIX STEELS**

# **Roofing & Cladding Manufacturer**

**Speedwell Road  
Birmingham  
B25 8ET**

**phoenixsteels.com  
sales@phoenixsteels.com  
0121 707 0165**

# Products

\*Tap/click title to jump to product



Box Profile



Corrugated Profile

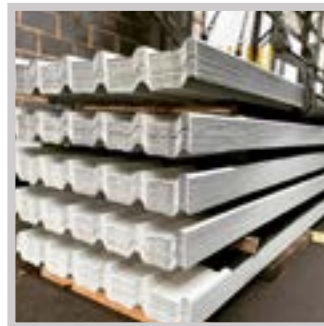

Anti-Condensation



GRP Roofing Lights

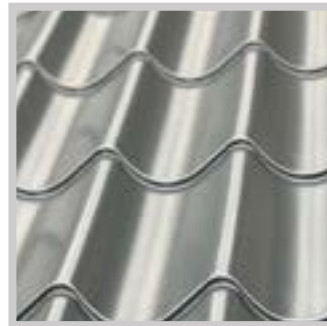

Tile Form Sheets

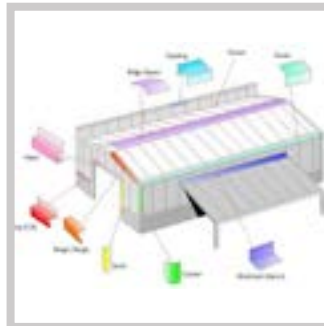

Flashing & Guttering



Internal Lining System



Over Roofing & Cladding



Z Purlins & C Sections



Fixings

## Prime Quality – Outstanding Service – Unbeatable Value

### Colourcoat

TATA Colourcoat Plastisol is produced to an exclusive formulation. BSC pioneered the development of Plastisol coatings and they are found on more UK cladding sheets than all other types added together.

The thick 200 micron coating is tough, and can withstand rough treatment in the workshop, during transit and on site. It is also durable and has good colour stability and opacity. The colour range consists of 20 shades and the accent colours. Other colours are available in stock and upon request.

In normal environments in the UK, and given proper maintenance, Colourcoat can have a life expectancy on the weatherside of over 40 years. Regular attention is necessary and recommended to achieve lasting life with the first usually being 10-25 years depending on the environment, the profile, the orientation and the colour.



### Fire Properties

Manufactured from steel, all profiles are designated as AA to B.S.476 Part 3 thereby deemed to satisfy provisions of The Building Regulations 1985 Approved Document B, Appendix A, Table A4 Part II.

Profile sheets are also designated as Class 0 to The Building Regulations by virtue of tests to 8.5.476 Part 6 (1>12;1>6) combined with a Class 1 surface spread of flame to 8.5.476 Part 7

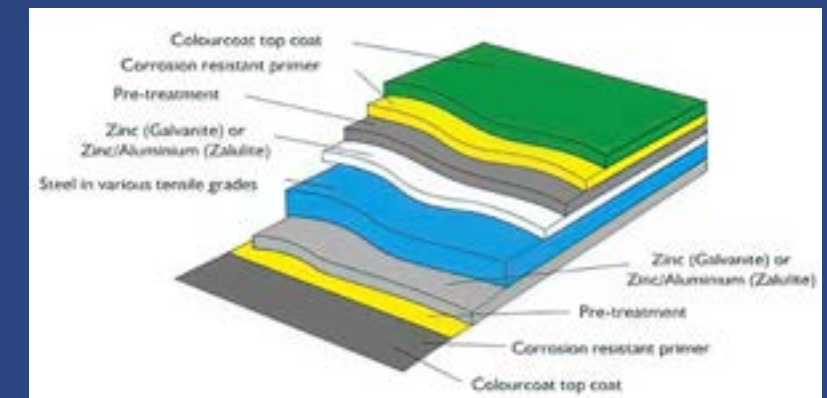

# Box Profile



## BOX PROFILE SHEETS

### Sheets available from 1m to 12m

Phoenix Steels offer Box Profile sheets in lengths ranging from 1m up to 12m long and work on a metre coverage including overlap. For example 5 sheets will cover 5 metres wide exactly.

With fast and easy install, our box profile sheets are a great choice for industrial, agricultural, commercial and domestic roofing and cladding. These can be used as single skin sheeting, for the over clad of an existing roof or part of a built up insulated system.

[View Webpage](#)

# Box Profile Specifications

Application:	Wall or Roof (Vertical & Horizontal)
External Finish:	Plastisol, Polyester or Glavanized
Internal Finish:	Light grey Polyester
External Face:	Profiled 32/1000, 32mm profile height, 200mm pitch centres
Standard Width:	1000mm when lapped
Max Length:	12m in 0.7mm sheet thickness – 6m in 0.5mm sheet thickness
Minimum Pitch:	5 degrees
Gauge Thickness:	0.5mm and 0.7mm
Weight:	0.5mm thickness – 4.78kg/m <sup>2</sup> , 0.7mm sheet thickness – 6.22kg/m <sup>2</sup>



# Box Profiles

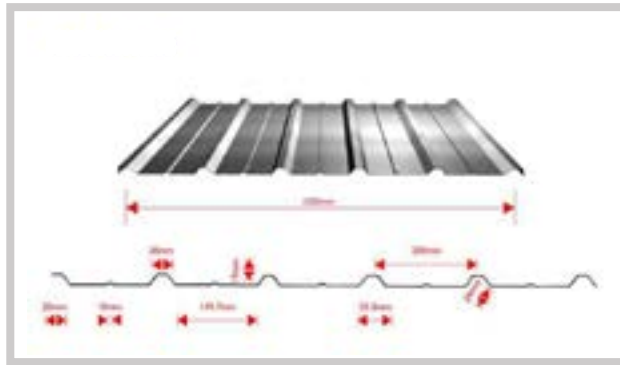

PS L 19/1000

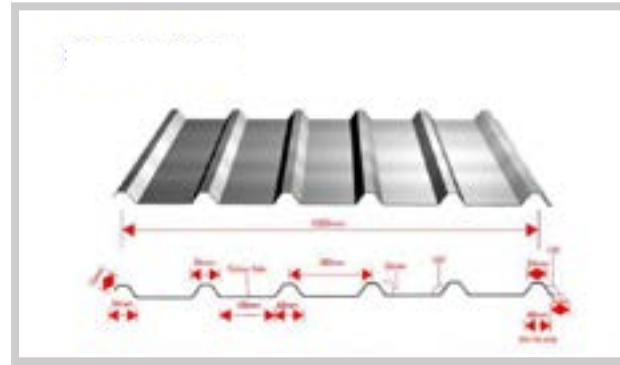

PS R 32/1000

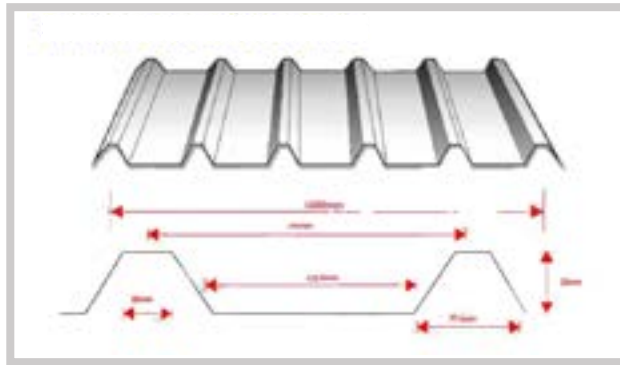

PS R 33/1000

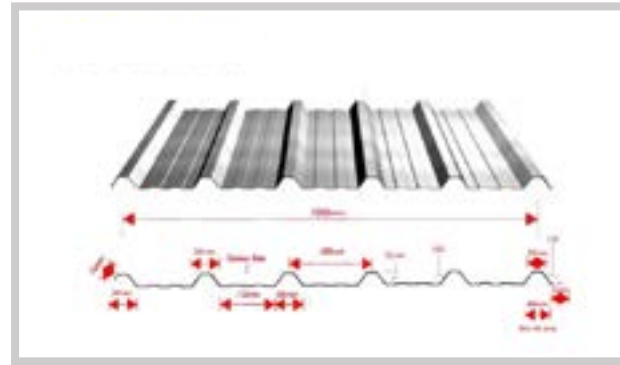

PS RR 32/1000

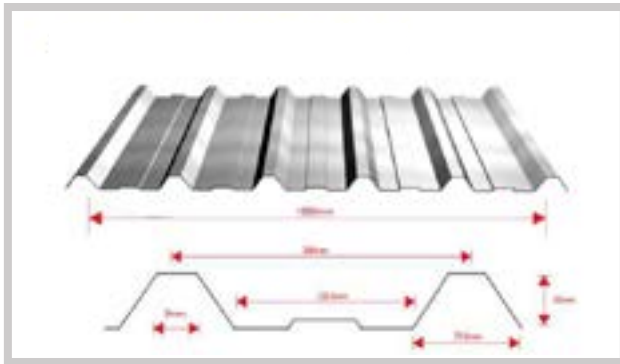

PS RR 33/1000

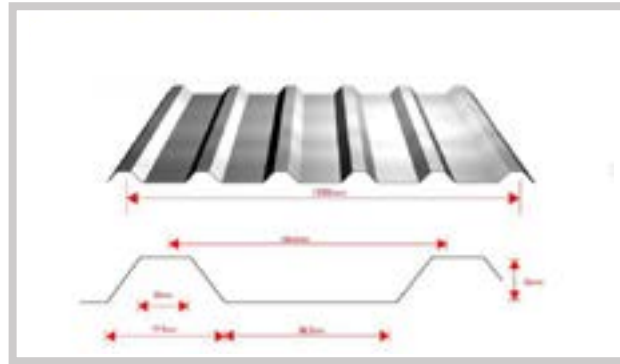

PS R 26/1000

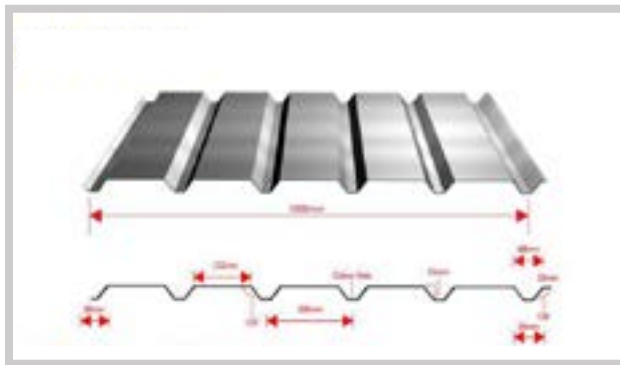

PS W 32/1000

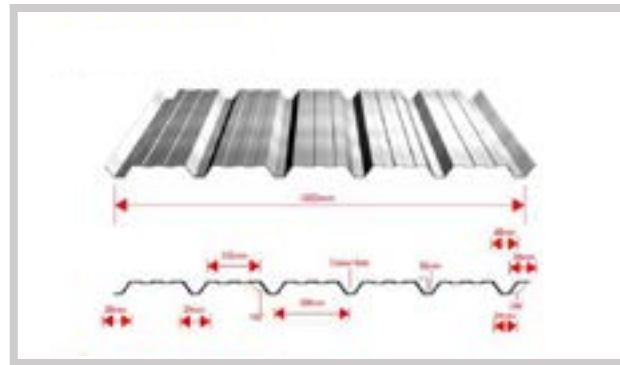

PS WR 32/1000

# 3" Corrugated

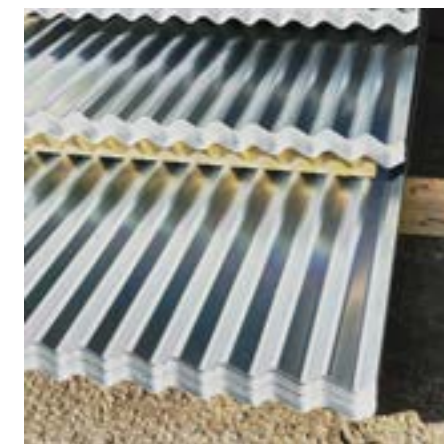
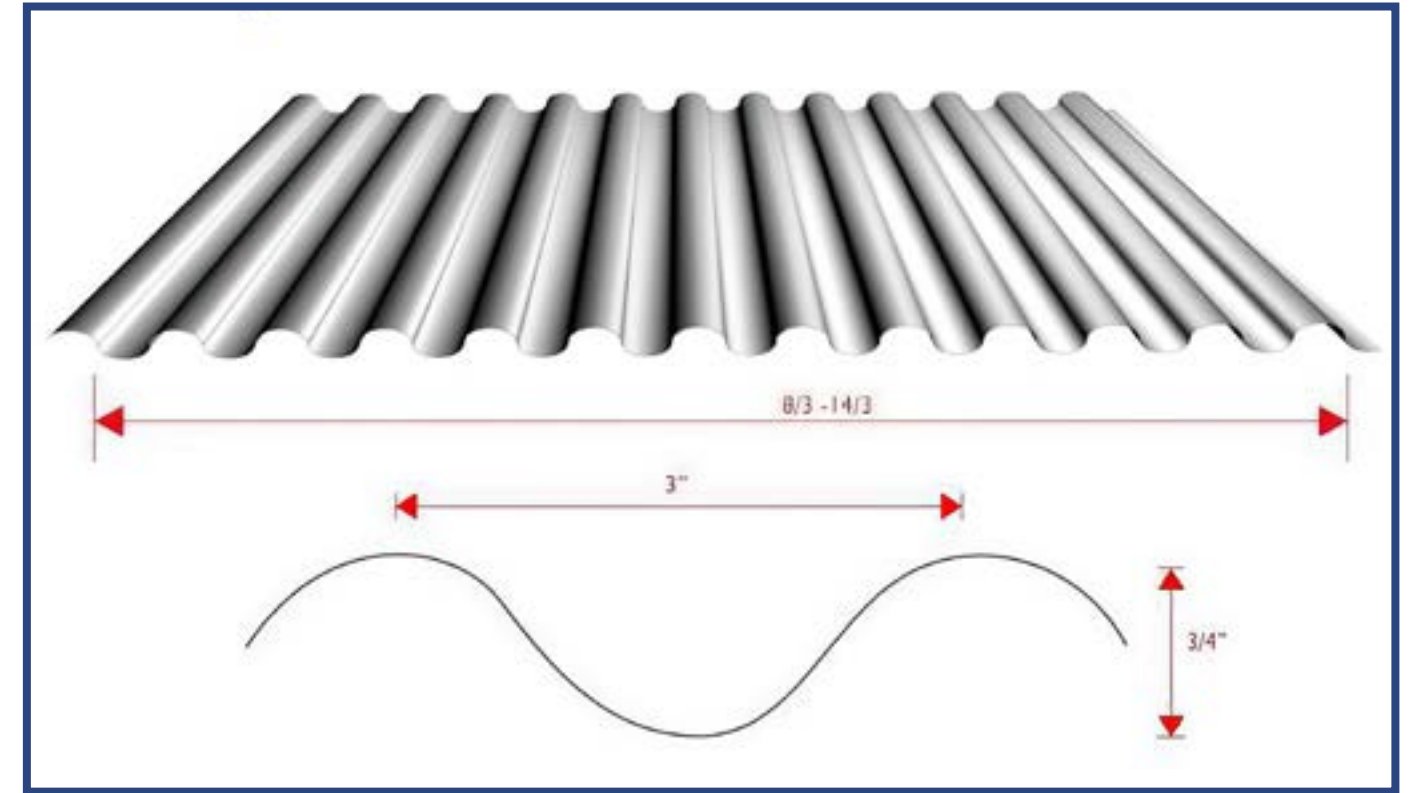

## 3" CORRUGATED SHEETING

### Sheets available from up to 12m

3" Corrugated Sheeting is available in the same range as our box profile, Galvanized, Polyester and the Plastisol (PVC) Leather Grain finish.

We offer this in 1m cover and 763mm cover. However the 1m cover is only available in lengths up to 12ft 6" long.

The 763mm cover can be rolled in any length ranging from 1m up to 12m long. The corrugated has a more agricultural feel to it and is commonly used in the farming industry and the fencing industry.

[View Webpage](#)



# 3" Corrugated Specifications

<b>Application:</b>	<b>Wall or Roof (Vertical &amp; Horizontal)</b>
<b>External Finish:</b>	<b>Galvanized, Polyester and Plastisol (PVC)</b>
<b>Internal Finish:</b>	<b>Light Grey Polyester</b>
<b>Standard Width:</b>	<b>1000mm when lapped</b>
<b>Available Lengths:</b>	<b>Available in any length up to 12 meters</b>
<b>Minimum Pitch:</b>	<b>5 degrees</b>
<b>Gauge Thickness:</b>	<b>0.5mm and 0.7mm</b>
<b>Weight:</b>	<b>Approx 2.6kg/m<sup>2</sup></b>

3" corrugated available in lengths up to 24ft/7.3m

Available in our wide range of colours

Fits alongside our GRP profiles

A large amount of 3" corrugated steel profile sheets and GRP roof lights are constantly kept in stock in lengths up to 24ft/7.3m. Standard lengths are 6ft, 8ft, 10ft and 12ft but can be manufactured to suit too. All roof lights can be cut to exact length.

When fitting our 3" corrugated the fixing is to be put through the top of the profile with one of our self tapping tek screws which has a water sealant washer. The standard length of the fixing should be approx 45mm to allow for the profile of the sheet and then to allow a solid fix into the purlin whether that be timber, light metal or heavy metal.

# Anti-Condensation Barrier

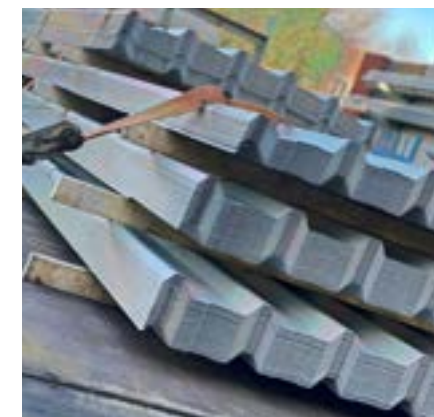

## ANTI-CONDENSATION BARRIER

The Phoenix Steels Anti-Condensation Membrane is a product designed to eliminate the problem of condensation. When the temperature and humidity conditions reach the dew point, the moisture condenses on the underside of the metal roof and forms droplets of water.

This membrane has many benefits from reducing the potential risk of damage to the contents of the building to protect animals and keeping them dry throughout the year. This is a more cost effective way of stopping condensation rather than insulating the roof with products such as a composite panel.

Anti-condensation backing is available on Box Profile, 3" Corrugated and our Phoenix Steels Tile Form.

[View Webpage](#)



# GRP Skylights

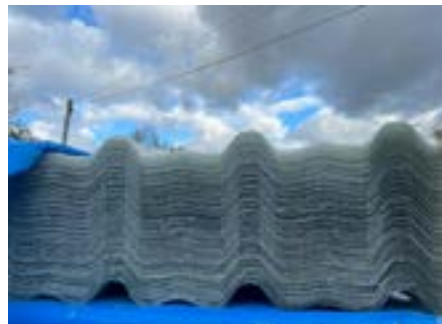

## GRP SKYLIGHTS

**Roof lights are ideal for any project ranging from large agricultural buildings to small canopies.**

GRP rooflights/skylights (Glass Reinforced Plastic) are fibre glass sheets that are used to allow natural daylight to enter a building and are made to fit with Phoenix Steels profiled steel sheeting (both 3" corrugated and box profile).

Phoenix Steels stocks lengths ranging from 6 ft to 24 ft and we can even cut to size to fit your needs if required. Longer lengths are available to order when requested in advance.

The advantage of replacing some of the steel sheets with our GRP roof lights is that letting natural day light in creates saving in costs such as electricity.

[View Webpage](#)

# GRP Profiles

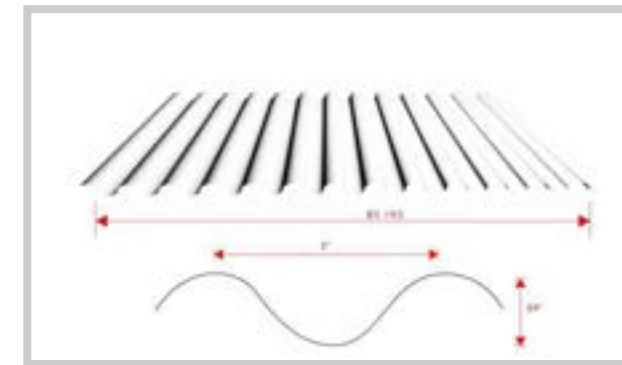

GRP 3" Corrugated

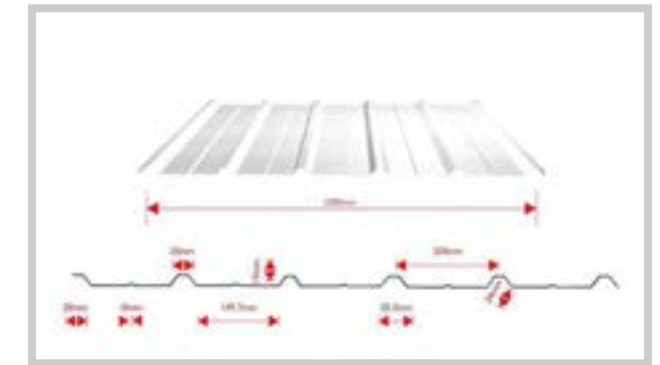

GRP 19-1000

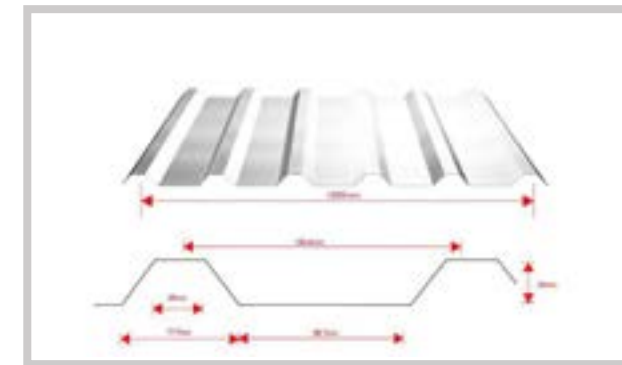

GRP 26-1000

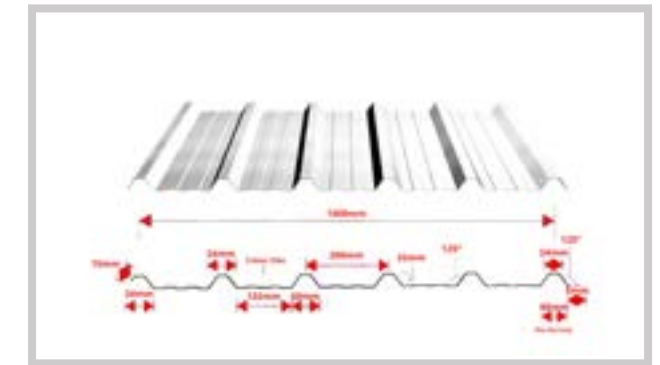

GRP Ribbed 32-1000

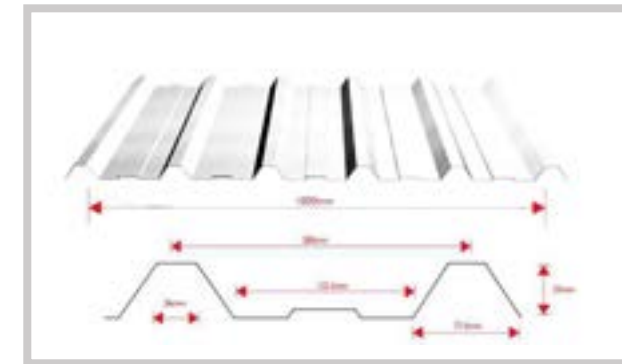

GRP Ribbed 33-1000

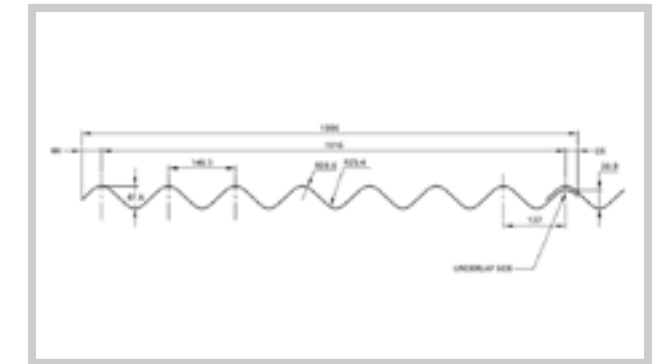

GRP Big 6 Profile



# GRP Specifications

Application:	Wall or Roof (Vertical & Horizontal)
External and Internal Finish:	GRP Fibre Glass
Standard Width:	1000mm Cover
Available Lengths:	6ft to 24ft (can be cut to suit)
Minimum Pitch:	5 degrees
Gauge Thickness:	2.4mm
Weight:	Approx 2.6kg/m <sup>2</sup>

# Tile Form

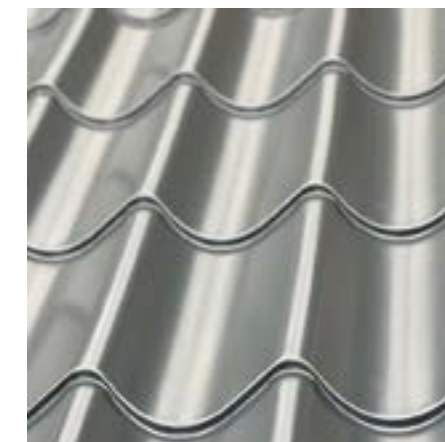

## TILE FORM SHEETING

### “Lightweight with an elegant appearance”

The Phoenix Steels Tile Form roof sheeting is a practical decision both for new and refurbishment projects. This profile is great for all environments.

The Tile Form is manufactured to length to suit your needs in our wide variety of colours. The fixing is recommended to go through the trough of the profile.

The unique high capacity drainage channel is manufactured on every sheet to guarantee the water tightness to suit weather conditions all year round.

[View Webpage](#)



# Tile Form Specifications

Application:	Roof Vertical
External Finish:	Plastisol (PVC)
Internal Finish:	Grey Polyester
External Face:	55mm profile height, 280 - 320mm pitch
Standard Width:	1020mm once overlapped
Max Length:	12 meters
Minimum Pitch:	10 degrees
Gauge Thickness:	0.7mm
Weight:	Approx 7.5kg/meter

# Flashings & Guttering

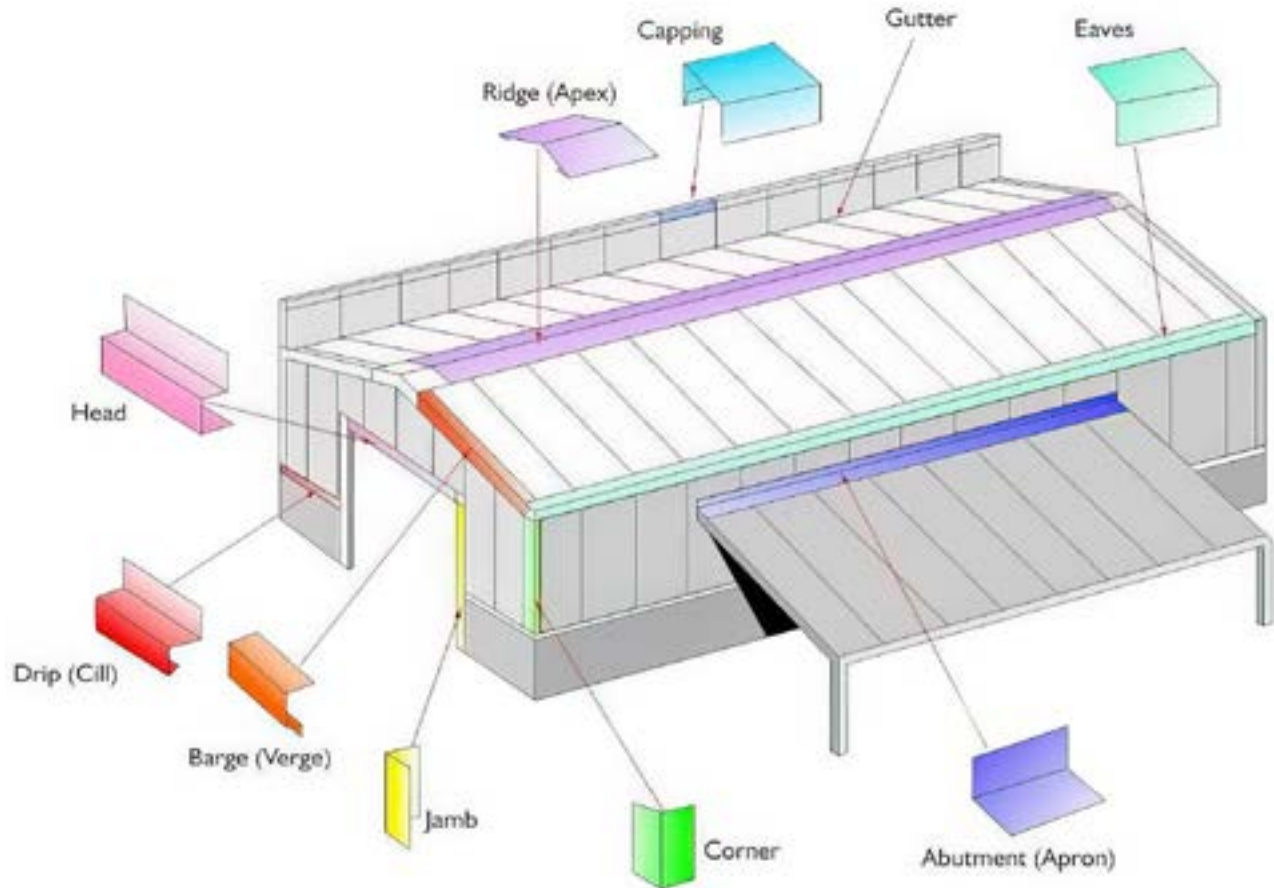

## FLASHINGS & GUTTERING

**All available in our colour range, both polyester and plastisol.**

At Phoenix Steels, like the profiled sheeting, all flashings and guttering can be made to order to suit your needs. However, with flashings such as barge and ridge capping, we keep a large amount of stock which are 200mm x 200mm wide in a range of colours.

[View Webpage](#)



# Flashing & Guttering Products



Capping

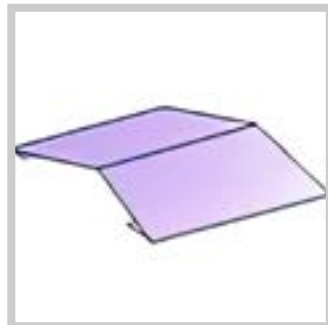

Ridge (Apex)



Head

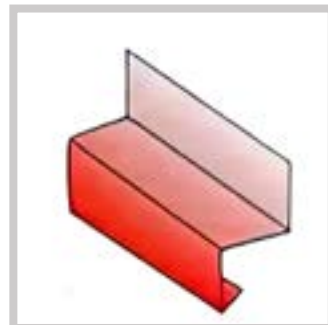

Drip (Cill)

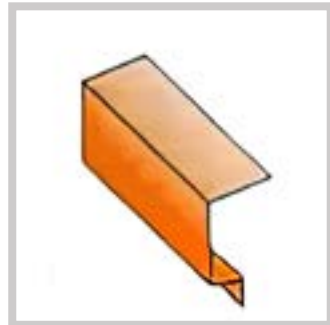

Barge (Verge)

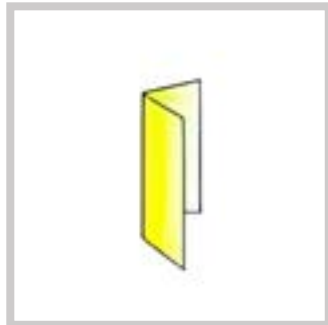

Jamb

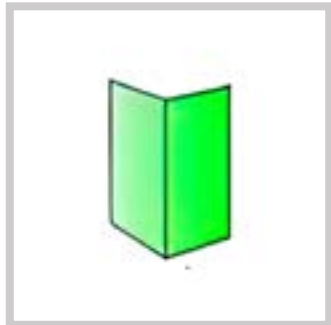

Corner

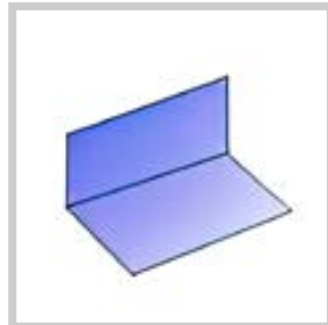

Abutment (Apron)

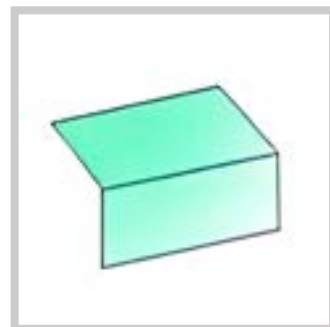

Eaves

# Internal Lining System



## INTERNAL LINING SYSTEM

### A Twin Layer System

This is a twin-layer system comprising of a top sheet, mini z spacer bar, fiberglass insulation, and a white liner panel. This is a cost-effective solution and is great for insulating buildings.

The additional level of insulation stops condensation as well as provides the building with a much more energy-efficient roofing solution. A variety of insulations and thicknesses are available to suit different building types upon request.

[View Webpage](#)



# Over Roofing & Cladding



## OVER ROOFING & CLADDING

### For Existing Roofing Systems

The overlaid system fully encapsulates the existing roof thus providing a waterproof solution without the inconvenience and cost of removing the original roof.

Overclad installations are more affordable entry-level cladding systems, most commonly used to overclad existing walls and roofs, including asbestos roofing. Once in place they provide a newer, more up to date look to buildings.

Single-skin and overclad installations are ideal in environments where minimal disruption to the business is required. Insulation is not compulsory for this if it is not required as you can simply use the mini z rail and top sheet only.

[View Webpage](#)

# Z Purlins & C Sections

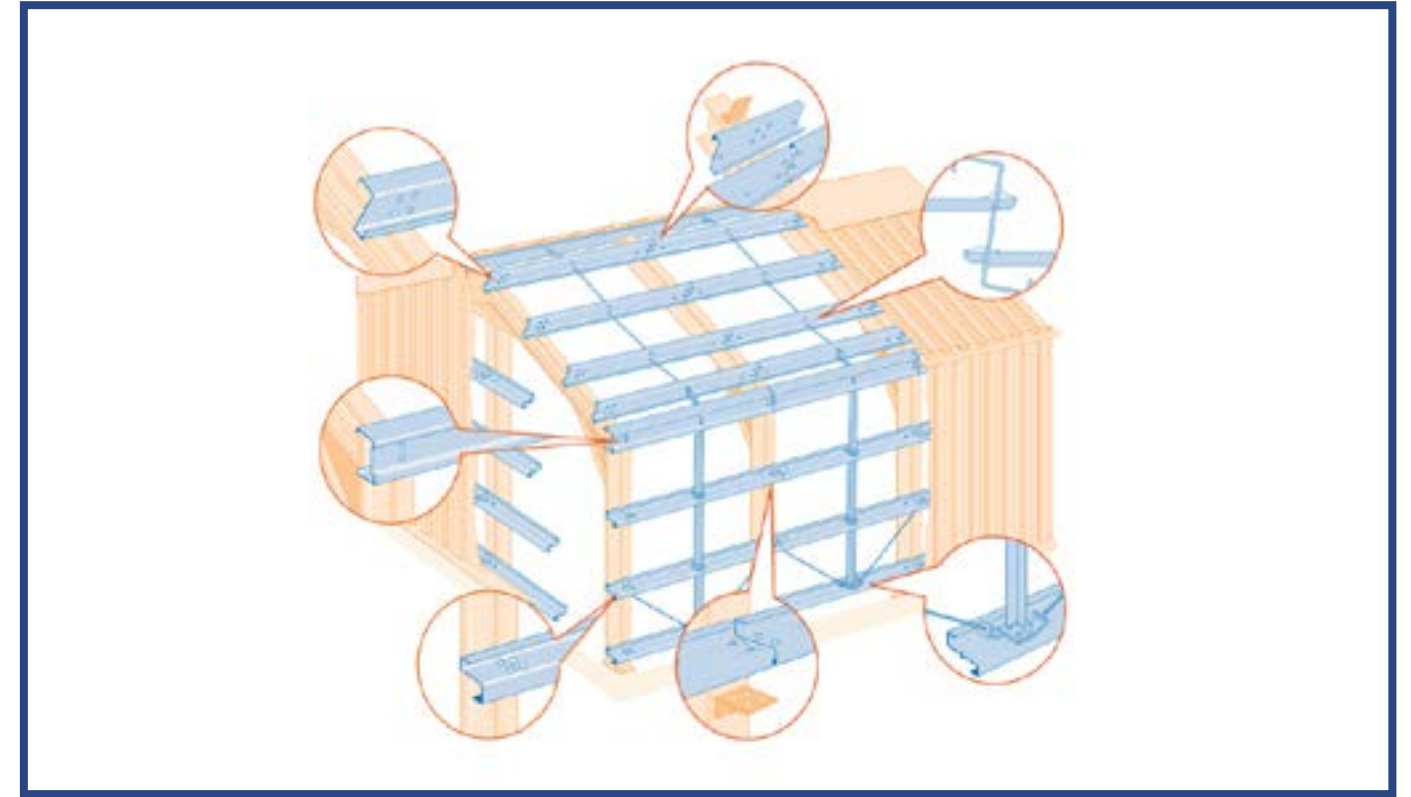

## Z PURLINS & C SECTIONS

Phoenix Steels are a Cold Roll forming Specialist producing a complete range of Zed Purlins, Eaves Beams, Side Rails, and Accessories. We offer a fast, no-frills manufacturing service concentrating on the essentials.

Both standard punch and plain purlins are both offered as Z & C Purlins.

You can order directly from a member of our sales team, and they are your point of contact until you are satisfied with completion.

[View Webpage](#)



# Z Purlins & C Sections Products

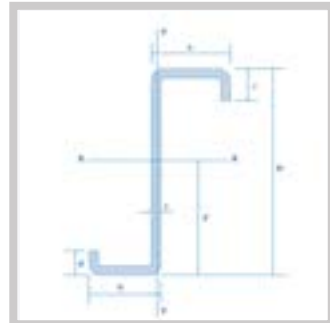

Z Purlin



Eaves Beam

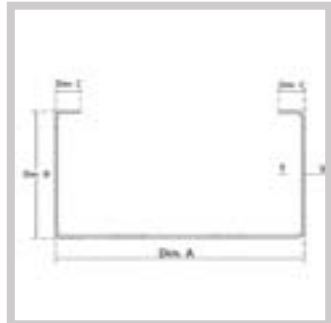

C Section

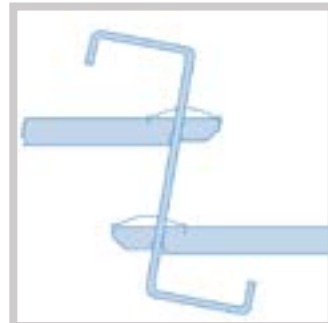

Anti-Sag Fixings



Z Purlin Sleeved Systems



Butt Systems



Side Rail Sleeve System



Side Rail Butt System



Diagonal Tie Wires

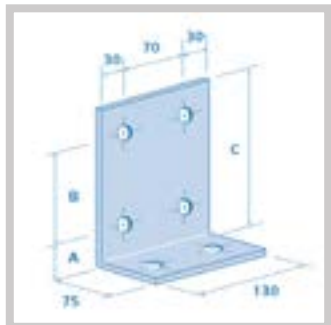

Purlin Cleat

[Download Complete PDF](#)

# Fixings



## SELF DRILLING TEK FIXINGS

**At Phoenix Steels we offer a range of quality fixings suitable for all our roofing products.**

Light metal, heavy metal, stitchers, and timber fixings are all available in various lengths. All fixings have easy application and constructed from high-quality materials for a long-lasting fix. Various lengths are available in all fixings.

For more information on our fixings please contact our sales team on 0121 707 0165.

[View Webpage](#)



Stitch Fix



Timber Tech Fix



Light Metal Fixings



Heavy Metal Fixings

